

EMC PRODUCTS

BASED ON
NANOCRYSTALLINE VITROPERM



ADVANCED MAGNETIC SOLUTIONS

VAC[®]
VACUUMSCHMELZE



THE COMPANY VACUUMSCHMELZE

VAC is a leading manufacturer of magnetic materials and solutions. We passionately advance the technologies of today and tomorrow. As a reliable partner, we work with our customers to develop application solutions that make it possible to meet constantly increasing requirements. We push technical boundaries with groundbreaking solutions. The use of our materials

ADVANCED MAGNETIC SOLUTIONS

as well as our refined solutions and their special magnetic properties are the key to making our customers' systems smaller, lighter, more efficient and, last but not least, safer. Thereby we contribute significantly to the saving of resources and the protection of our environment.

Contents

Introduction	Page 3
Superior EMC filter- and common mode choke design	Page 5
VITROPERM vs. ferrite	Page 7
Properties of VITROPERM	Page 8
Design advantages	Page 12
Standard series VITROPERM cores	Page 14
Core stacks	Page 18
Common mode chokes (standard UL1446)	Page 20
Further design support	Page 24
Common mode choke design checklist	Page 26

EMC PRODUCTS

BASED ON

NANOCRYSTALLINE VITROPERM

Nowadays power electronics have a decisive influence on the technology of electrical energy generation, distribution and conversion. Modern semiconductors enable electrical energy to be controlled and converted rapidly and safely with low losses. However, using today's fast switching technologies results in

significant network disturbances. To minimize these disturbances and stabilizing electric networks, EMI filters according to latest international standards must be used. VAC's VITROPERM® EMC products make a significant contribution in building innovative and compact filter designs with lowest losses.

Our EMC products are used in a wide range of applications:

- **Switched-mode power supplies (SMPS)**
- **Solar inverters**
- **Frequency converters**
- **EMC filters**
- **Welding equipment**
- **Wind generators**
- **Induction hobs**
- **Automotive applications**
- **Uninterruptible power supplies (UPS)**

® = Registered Trademark of VACUUMSCHMELZE GmbH & Co. KG

VITROPERM – EXTENDING THE POSSIBILITIES OF IRON

Nanocrystalline VITROPERM alloys are based on Fe with Si and B with further additions of Nb and Cu. VAC pioneered the development of rapid solidification technology resulting in the production of thin tapes or ribbons approximately 20 μm thick. Special slitting and core winding machines produce tape-wound cores with external diameters ranging from 2 mm to 600 mm. A subsequent heat treatment at around 500 - 600 $^{\circ}\text{C}$ transforms the initially amorphous microstructure of the tape into the desired nanocrystalline state, this being a two-phase structure with fine crystalline grains (average grain diameter of 10 - 40 nm) embedded in an amorphous residual phase.

VITROPERM nanocrystalline alloys are optimized to combine highest permeability and lowest coercive field strength. The combination of very thin tapes and the relatively high electrical resistance (1.1 - 1.2 $\mu\Omega\text{m}$) ensures minimal eddy current losses and an outstanding frequency vs. permeability behaviour. Combined with a saturation flux density of 1.2 T and wide operational temperature range, these features combine to make VITROPERM a universal solution for most common EMC problems and vastly superior in many aspects to commonly used ferrite and amorphous iron materials.

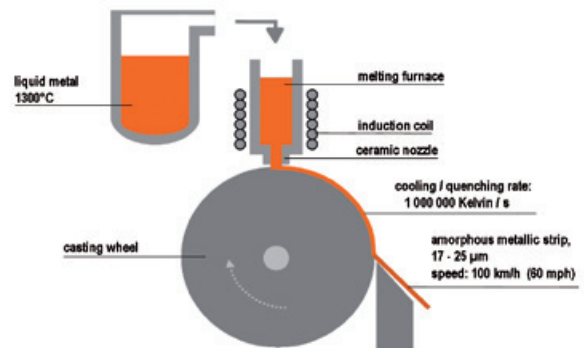

with an amorphous structure (metallic glass).

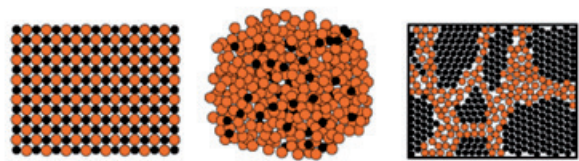

Fig 2: Crystalline structure, amorphous structure, nanocrystalline micro-structure

SUPERIOR EMC FILTER AND COMMON MODE CHOKE DESIGN

Nanocrystalline cores are widely used in common mode choke (CMC) applications due to their unique combination of properties. By utilising low-cost raw materials (Fe-based) and modern, large-scale production, VITROPERM is a very competitive solution for a wide range of applications.

Our CMCs feature high attenuation which is maintained across a wide frequency range offering extremely broadband attenuation. In many cases, this characteristic can allow a reduction of the number of filter stages in multistage EMC filter configurations to reduce complexity, cost and filter volume. Ohmic (copper) losses are also reduced increasing the efficiency and lowering component temperature.

VACUUMSCHMELZE has extensive practical and theoretical expertise in the design of CMCs and filter configuration using nanocrystalline cores and components. At higher frequencies, the winding configuration has a major effect on the parameters of winding capacitance and leakage inductance and is therefore carefully considered in our choke designs. Figure 4 shows a comparison of insertion loss for two chokes which differ only in their winding configuration (core material, number of turns and wire thickness are identical in both cases). This illustrates how our design expertise can improve filter efficiency, maximize reliability and reduce costs.

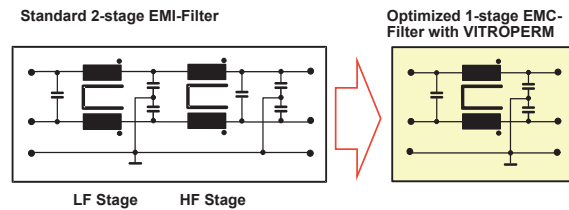

Fig. 3: Nanocrystalline chokes allow a reduction of filter stages

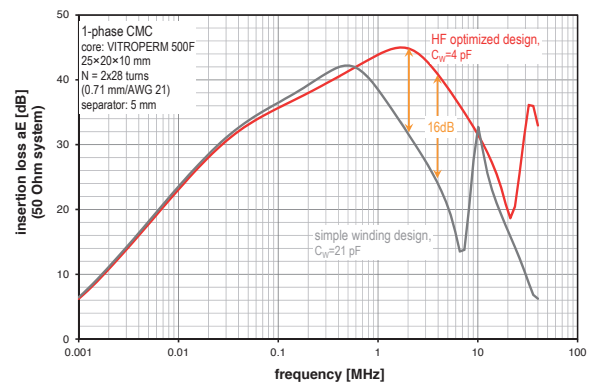

Fig. 4: Optimized choke design: improved attenuation of up to 16 dB (or more) at 4 MHz

FEATURES & BENEFITS OF VITROPERM NANOCRYSTALLINE CHOKES



ADVANTAGES	PRECONDITIONS / RELEVANT PROPERTIES
Small size	High μ , high B_s
Suitable for high currents and/or high voltages	High μ , high B_s , suitable core geometries
Single stage filter designs possible	Excellent broadband attenuation behaviour, high permeability, low-capacitance design, moderate reduction of μ up to high frequencies, low Q factor in 150 kHz range
High efficiency, low power loss	Low number of turns required for high L, reduction of filter stages
'Green', environmentally friendly	Low power loss, reduced use of material
Suitable for high and low ambient temperatures and high operating temperatures	High Curie temperature, material properties (μ , B_s , λ_s) nearly independent of temperature
'Easy filter design'	Material properties (μ , B_s , λ_s) nearly independent of temperature, linear magnetization curve delivers stable impedance across a broad range of common mode currents – VAC choke design software available
UL-compliant designs	Suitable plastic materials meet UL1446 insulation requirements
Optimized solutions for a variety of different applications	A range of μ levels and VITROPERM alloys available
No operating noise	Material is practically magnetostriction-free
Best suited for winding of thick wires	Material is practically magnetostriction-free, coatings/casings are resistant against mechanical stress

VITROPERM VS. FERRITE

Due to the optimized high-frequency properties, the insertion loss of our nanocrystalline common mode chokes is superior compared to that of a typical ferrite choke in the relevant frequency range.

The properties of VITROPERM are very much different from conventional ferrites. In low-frequency ranges the permeability of VITROPERM 500 F is higher than that of ferrites. Nanocrystalline materials show a less marked reduction of permeability μ at higher frequencies. This has to be considered in the filter design for optimum solutions. The main physical and magnetic characteristics are illustrated in the following diagrams.

The permeability μ of VITROPERM 500 F is significantly higher than the μ of ferrites in the low frequency range. At higher frequencies the μ of both nanocrystalline materials remains above that of ferrites. A high choke impedance is preferred for a high attenuation. To achieve high impedance, high permeability core material rather than an increased number of turns must be used, as a low number of turns leads to low winding capacity and thus superior HF properties. VAC has focused on the favourable material properties of nanocrystalline cores to build an extensive practical and theoretical experience in the design of common-mode-chokes and filters. VAC's optimized chokes offer clearly improved HF-properties.

INSERTION LOSS

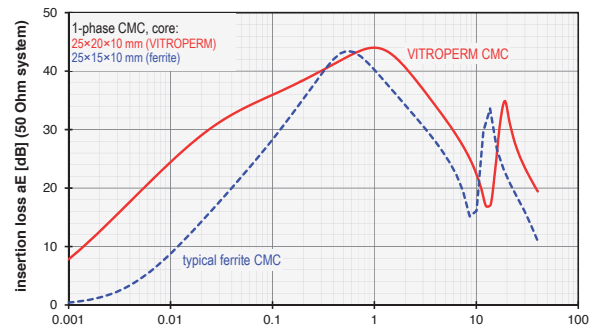

Fig. 5: Comparison of insertion loss of VITROPERM and ferrite

PERMEABILITY

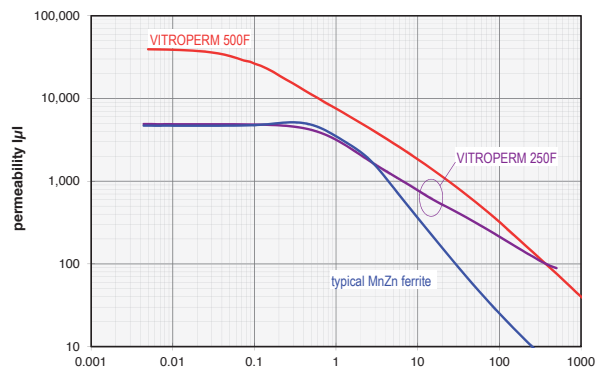

Fig. 6: Frequency response of the permeability of VITROPERM 500 F ($\mu = 40,000$) and VITROPERM 250 F ($\mu = 5,000$) in comparison to a typical MnZn ferrite ($\mu = 5,000$)

PERMEABILITY AND MAGNETIZATION CURVE

As properties like the frequency dependence of permeability (fig. 7), $\mu(f)$ of VITROPERM 500 F and ferrites differ fundamentally, varied filter designs must be considered for optimization, the permeability of ferrites ($\mu=5,000$) shows a flat and linear characteristic up to approximately 1 MHz (ferrites with $\mu=10,000$ range up to approximately 200 kHz). In this flat range, the attenuation properties are determined by μ' and the impedance $|Z|$ is dominated by the inductance L . If the self-resonance of the choke is within this frequency range, the attenuation curve is narrowband and attenuation is primarily caused by reflection of the interference signal. The attenuation of ferrites is determined by its resistive parameters at frequencies above the frequency where the flat range of the curve ends, because the real part of the impedance $\text{Re}(Z)$ accounts for the major share of the attenuation and the imaginary part of the complex permeability μ'' becomes the dominant factor. If the self-resonance of the choke is in this frequency range the attenuation characteristic becomes increasingly broadband.

VITROPERM is basically similar in this respect. The flat sector of $\mu(f)$ of VITROPERM 500 F ranges (depending on the initial permeability level) to frequencies of several 10 kHz (20 kHz in this example), only. Consequently, attenuation (or $|Z|$) is already dominated by $\text{Re}(Z)$ and is always broadband in the whole EMC-relevant range above 150 kHz. Inductance plays a minor role and describes the attenuation only partially. The determining factor is the total impedance. The approximation $|Z| = \omega L$ is valid for ferrite chokes. For VITROPERM chokes $|Z| \gg \omega L$ applies. Attenuation primarily does not result from a reflection of the interference signal, but from its absorption.

Only if the different characteristics are considered, the design of optimized, compact and low-cost nanocrystalline chokes is possible. However, VITROPERM 250 F is an exception, because the flat $\mu(f)$ sector range is similar to $\mu=5,000$ ferrites to frequencies of up to 1 MHz and the attenuation is primarily inductive (fig. 8 a and b).

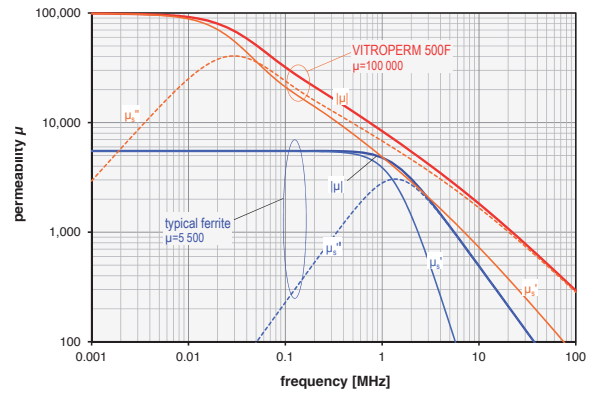

Fig. 7: Differences in the balance between μ' and μ'' for VITROPERM and ferrite lead to different attenuation mechanisms

MAGNETIZATION CURVE

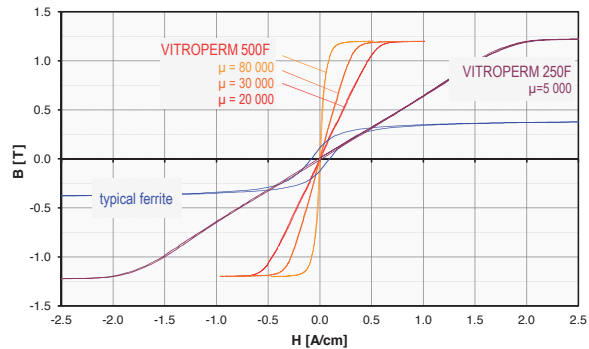

Fig. 8a: Hysteresis loops for various types of VITROPERM and typical MnZn ferrite

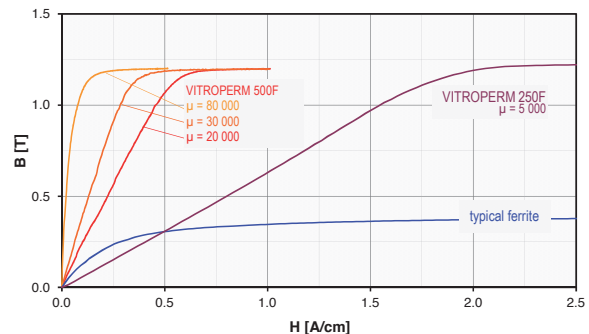

Fig. 8b: Magnetization curve of VITROPERM 500 F and VITROPERM 250 F in comparison to typical MnZn ferrite, showing noticeable differences in permeability (slope of the curve) and saturation flux density (B_s)

THERMAL PROPERTIES

The saturation flux density of VITROPERM changes by only a few percent in the operating temperature range of up to 150 °C, while MnZn ferrites decline by up to 40% at temperatures above 100 °C (fig. 9). The high Curie temperature of VITROPERM alloys (above 600 °C), allows short term maximum operating temperatures as high as 180-200 °C¹⁾.

The permeability of VITROPERM typically changes by less than 10% in the temperature range from -40 °C to 120 °C, while the permeability of MnZn ferrites can drift in a range of ± 40 - 60% around the room temperature value (fig. 10).

THERMAL BEHAVIOUR

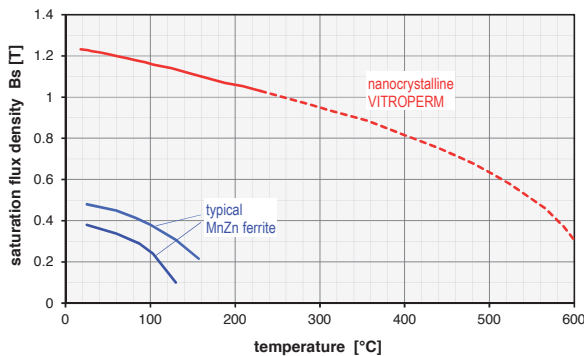

Fig. 9: Temperature dependence of saturation flux density $B_s(T)$

Insertion loss (and impedance) of a CMC made of VITROPERM 500 F is almost temperature-independent in the temperature range of -40 °C to above 150 °C (fig. 11a).

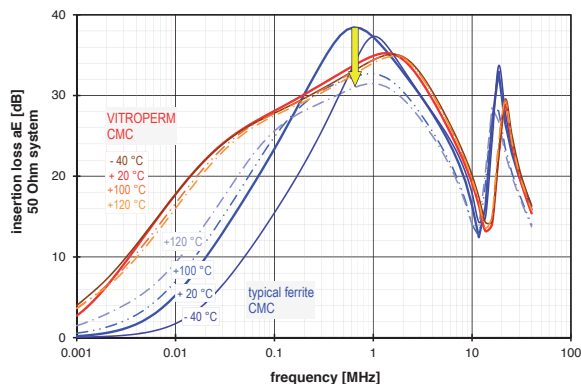

Fig. 11a: Comparison of temperature dependence of insertion loss of a VITROPERM CMC and a choke with standard MnZn ferrite core

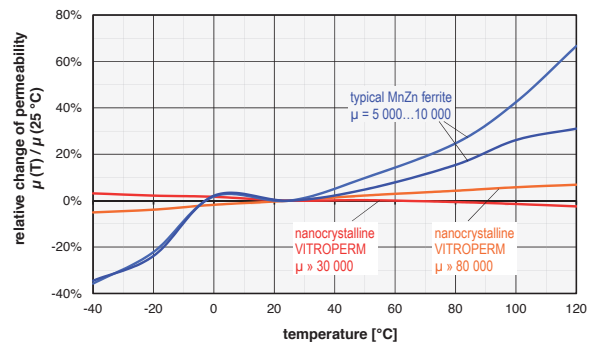

Fig. 10: Relative change of $\mu(T)$ at $f = 100$ kHz, normalized for room temperature

In contrast, ferrite chokes feature a significant drop of insertion loss with increasing temperature (fig. 11b).

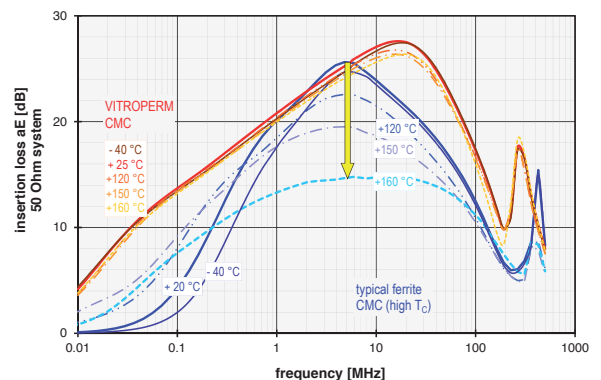

Fig. 11b: Comparison of temperature dependence of insertion loss up to 160 °C of a VITROPERM CMC and a MnZn choke using a high Curie temperature ferrite material

¹⁾ Maximum continuous temperature depends on the casing/coating materials used. Please contact VAC for more detailed information.

SATURATION BEHAVIOUR

High permeability nanocrystalline cores enable very high inductance levels in extremely compact core or choke dimensions. However, as a consequence, an increased sensitivity to asymmetric magnetization conditions caused by common mode, unbalanced or leakage currents has to be considered. These currents may occur as low-frequency leakage currents (50/60Hz) or as medium or high-frequency interference currents. These are caused for example by long motor cables with different capacitance of the individual conductors to earth, or by resonances which occur (commonly due to bearing currents) in such cables leading to short, extremely high and rapidly declining current peaks with amplitudes of up to several $10 A_{\text{peak}}$ and pulse widths in the nanosecond range (1 ... several 100 ns). If these common mode currents exceed the saturation level of the choke or core, the attenuation of the choke breaks down and the choke becomes less effective.

The saturation behaviour of ferrites is less sensitive due to its lower permeability. For applications with higher imbalance currents, the advantages of VITROPERM with 1.2 T saturation flux density (approximately 3 times higher than ferrites) can still be realised since VITROPERM is available in a range of permeability levels between 4,000 and 150,000. In these cases, a lower μ level may have to be selected in order to find the optimum saturation-resistant solution. Fig. 12a shows a comparison of saturation currents for different VITROPERM designs with a typical ferrite core of similar dimensions. It can be seen that the saturation behaviour of the MnZn ferrite ($\mu=6,000$) is comparable with that of VITROPERM 500 F ($\mu=17,000$) up to frequencies of approximately 50 kHz. At higher frequencies, however, the VITROPERM design is becoming more advantageous. The VITROPERM solution offers a 50% higher A_L value at 100 kHz and a significantly higher impedance (note that the impedance of

VITROPERM is determined to a small part by inductance L in this frequency range). High permeability VITROPERM 500 F cores are characterized by an extremely high attenuation or impedance at low frequencies, and they are clearly superior against ferrites at high frequencies. However, the price of this superior performance is a more sensitive saturation behaviour, which is improving with increasing frequency but still more critical than that of other core materials. It should be noted that fig. 12a shows the saturation currents of the cores without winding. Depending on the number of turns, the I_{cm} values of the chokes are some 10 mA to several 100 mA, only (see tables of standard series).

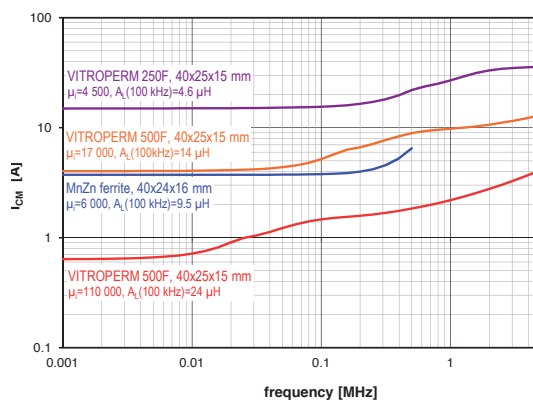

Fig. 12a: Comparison of saturation behaviour of VITROPERM 500 F, VITROPERM 250 F and MnZn ferrite

Fig. 12b shows permeability characteristics under DC bias field for a VITROPERM 500 F core ($\mu=20,000$) and 2 typical MnZn ferrites ($\mu=5,000$ and $\mu=8,000$, respectively). The diagram shows the significantly higher permeability and a square $\mu(H_{DC})$ characteristic of the nanocrystalline material in comparison to the rounded properties of the two ferrite cores. This behaviour complies to the linear magnetization curve of VITROPERM (figs. 8a/8b) and leads to nearly constant inductance over a wide range of the DC bias fields.

VITROPERM 250 F is always used where highly saturation-resistant solutions are required for applications with very high common mode or unbalanced currents. However, it cannot equal the high attenuation of VITROPERM 500 F.

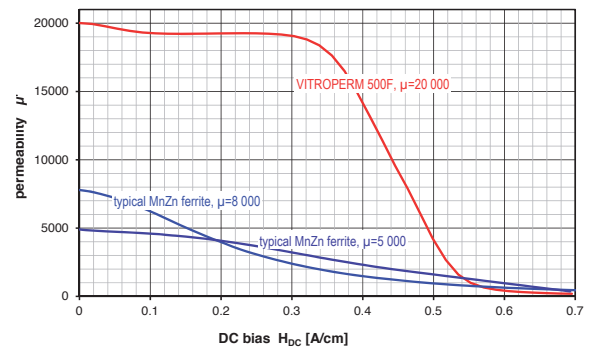

Fig. 12b: Comparison of permeability characteristics under DC bias field for VITROPERM 500 F and two typical MnZn ferrites

DESIGN ADVANTAGES WITH VITROPERM

The superior material properties of nanocrystalline VITROPERM enable common mode chokes with high inductance/impedance with a small number of turns, resulting in reduced copper losses, low winding capacitance and excellent HF performance.

Due to the high initial permeability, low winding capacitance and a low Q-factor (above 100 kHz) VITROPERM CMCs offer a broadband insertion loss curve ranging from 10 kHz up to several MHz and improved attenuation behaviour at both low and high frequencies, in comparison to conventional ferrite chokes with similar core dimensions and identical windings (see fig. 13).

Better attenuation properties and an extended operating temperature range allow a reduction of the component volume by a factor of up to 3 or more under similar conditions. Note that the insertion loss curve of the small VITROPERM choke in fig. 14 is similar to that of ferrite materials at frequencies of about 600 kHz - 1 MHz and is superior below 500 kHz and above 1 MHz.

The excellent attenuation of VITROPERM CMCs simplifies the filter design in a wide frequency range.

For laboratory tests, VAC offers different sample kits with selected standard cores and chokes.

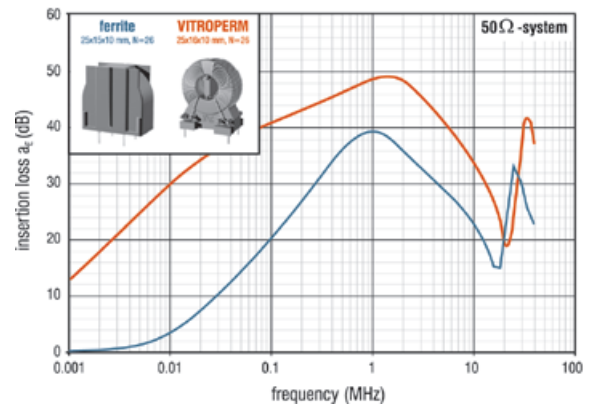

Fig. 13: Comparison of insertion loss curve of a VITROPERM 500 F CMC (red curve) and ferrite CMC (blue curve) of similar size and with the same number of turns

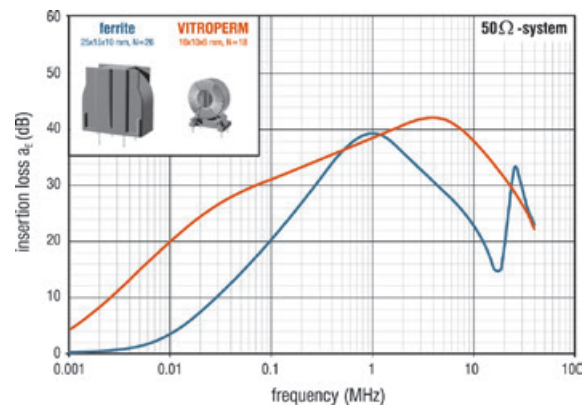
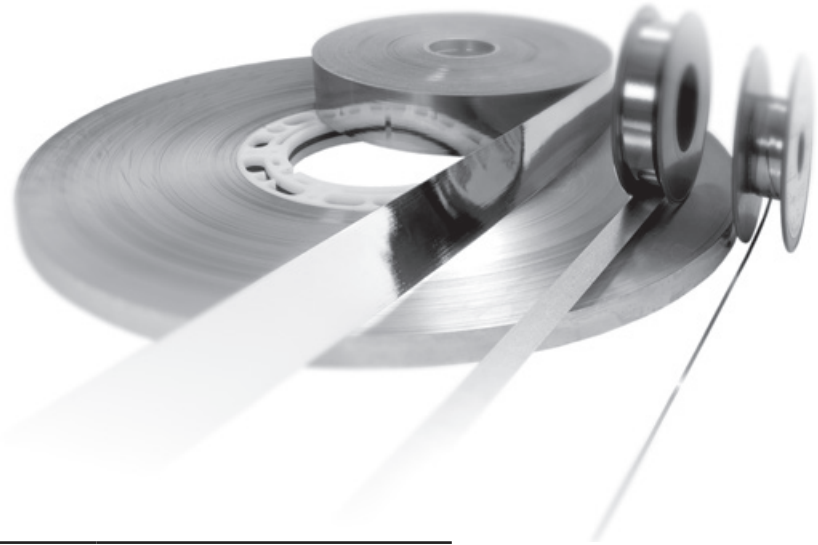

Fig. 14: Comparison of the dimensions of a VITROPERM 500 F CMC (red curve) and ferrite CMC (blue curve) with similar attenuation properties in the 1 MHz range



VITROPERM – TYPICAL DATA

Saturation flux density	$B_s = 1.2 \text{ T}$
Coercivity (static)	$H_c < 3 \text{ A/m}$
Saturation magnetostriction (λ_s)	
VITROPERM 500 F	$\lambda_s = 10^{-8} \dots 10^{-6}$
VITROPERM 250 F	$\lambda_s = \approx 8 \times 10^{-6}$
Specific electrical resistance	$\rho \approx 115 \mu\Omega\text{cm}$
Curie temperature	$T_c > 600 \text{ }^\circ\text{C}$
Max. operational temperature (T_{max})	
Epoxy coating	$T_{\text{max}} = 120 \text{ }^\circ\text{C}^{2)}$
Plastic casing	$T_{\text{max}} = 130/155 \text{ }^\circ\text{C}^{2)}$
Short-term	$T_{\text{max}} = 180 \text{ }^\circ\text{C}^{1)}$
Permeability (μ)	
VITROPERM 500 F	$\mu_i = 15,000 \dots 150,000$
VITROPERM 250 F	$\mu_i = 4,000 \dots 6,000$
Core losses (100 kHz, 0.3 T)	$P_{\text{Fe}} = 80 \text{ W/kg (typ.)}$

¹⁾ Please contact VAC for more detailed information about the temperature limits of our casing and coating materials.

²⁾ For continuous operation

STANDARD SERIES OF VITROPERM CORES

Our VITROPERM cores are available with different A_L -levels for many core sizes. Thus, saturation-resistant solutions are available for various fields of applications. Common mode currents may occur as interference currents, bias currents or, primarily, unbalanced currents. If the common mode currents exceed the saturation currents (I_{cm}) of the cores or chokes, cores with higher saturation resistance must be used. High A_L values (high μ) are more suitable for typical single-phase applications with low unbalanced current (e.g. switched-mode power supplies), while cores with lower A_L values are often used in 3-phase applications with high unbalanced currents (e.g. frequency converters with long motor cables).

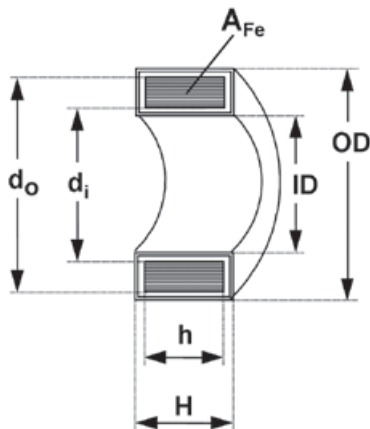

- A_{Fe} = iron cross section
- h = nominal height
- H = height (incl. coating/casing)
- ID = inner diameter (incl. coating/casing)
- OD = outer diameter (incl. coating/casing)
- d_o = nominal outer diameter
- d_i = nominal inner diameter

More detailed technical information and the data sheets are available at www.vacuumschmelze.com.

Please scan the QR-code belonging to this chapter which will lead you automatically to the respective site.



Table below



NANOCRYSTALLINE VITROPERM CORES WITH EPOXY RESIN COATING

Although the epoxy resin coating is suitable for direct winding, we recommend additional insulation between core and winding for enhanced insulation requirements. The epoxy resin is suitable for continuous operational temperatures of up to 120 °C (UL compliant 105 °C) and complies with the **UL94-V0 standard (UL File Number: E214934), class A (105 °C)**.

Part number T60004-	Nominal core dimensions $d_o \times d_i \times h$ mm x mm x mm	Limiting dimensions (incl. coating)			Iron cross section A_{Fe} cm ²	Mean path length l_{Fe} cm	Weight m g	A_L^*		Saturation current I_{cm}^{**} , typical	
		OD mm	ID mm	H mm				10 kHz nominal μH	100 kHz	10 kHz A	100 kHz A
L2016-W620 L2016-W619	16 x 12.5 x 6	17.8	10.7	8.0	0.08	4.5	2.6	15.0 6.0	4.8 3.9	0.32 1.1	0.63 1.7
L2022-W867	22 x 17 x 6	24.0	15.2	8.0	0.12	6.1	5.4	16.4	3.2	0.43	0.86
L2022-W868	22 x 17 x 10	24.0	15.2	12.0	0.20	6.1	9.0	27.4	5.3	0.43	0.86
L2025-W622 L2025-W621	25 x 20 x 10	27.3	17.5	12.3	0.19	7.1	9.9	22.5 9.0	7.2 5.9	0.5 1.8	0.99 2.8
L2030-W676	30 x 25 x 15	32.3	22.7	17.5	0.27	8.6	17.4	26.5	8.5	0.61	1.2
L2030-W911	30 x 20 x 10	32.5	17.8	12.5	0.40	7.9	23.1	56.0	13.4	0.42	0.87
L2040-W624 L2040-W623	40 x 32 x 15	42.3	29.1	17.8	0.44	11.3	36.0	32.5 13.0	10.4 8.4	0.8 2.8	1.6 4.4
L2045-W886	45 x 32 x 15	47.3	29.8	17.8	0.71	12.1	63.3	19.7	12.8	3.1	4.7
L2050-W626 L2050-W625 L2050-W583	50 x 40 x 20	52.3	37.1	22.8	0.73	14.1	76.0	43.0 17.0 11.2	13.8 11.0 10.0	1.0 3.6 5.5	2.0 5.6 7.1
L2063-W627 L2063-W721	63 x 50 x 20	65.5	46.6	22.8	0.95	17.8	124.0	18.0 13.5	11.7 12.1	4.5 6.9	6.9 8.9
L2080-W628 L2080-W722	80 x 63 x 20	83.0	59.5	22.8	1.24	22.5	205.0	18.5 12.0	12.0 10.8	5.7 8.7	8.7 11.0
L2100-W629 L2100-W723	100 x 80 x 20	104.0	75.0	23.0	1.46	28.3	303.0	17.3 11.2	11.2 10.0	7.1 11.0	11.0 14.0
L2130-W567 L2130-W630 L2130-W587	130 x 100 x 25	134.5	95.0	28.5	2.85 2.74 2.74	36.1 36.1 36.1	757.0 727.0 727.0	50.0 25.4 16.4	19.4 16.5 14.8	3.4 9.1 14.0	6.2 14.0 18.0
L2160-W631 L2160-W720	160 x 130 x 25	165.0	125.0	28.5	2.74	45.6	917.0	20.2 13.0	13.1 11.7	11.0 18.0	18.0 23.0
L2194-V105 L2194-W908	194 x 155 x 25	200.0	149.0	28.5	3.71	54.8	1,490.0	45.0 15.0	14.7 13.2	4.9 21.0	9.1 27.0

* A_L = inductance for N = 1 (tolerance +45%/-25%)

** I_{cm} : the listed saturation currents are guidelines only. They are calculated for nominal core dimensions at room temperature and for approx. 70% saturation flux density. The frequency-dependent saturation behaviour is demonstrated in fig. 12.

NANOCRYSTALLINE VITROPERM 500 F AND VITROPERM 250 F CORES IN PLASTIC CASING

The plastic cases are suitable for direct winding and offer good mechanical protection of the nanocrystalline core material. This enables the best magnetic properties and highest permeability levels to be maintained. Additional winding protection is optional for heavy wire windings, where there may be a danger of core damage. The plastic materials comply with the standards **UL94-V0/HB for small cores (UL File Number: E41871), class B (130 °C) and UL94-V0 (UL File Number E41938), Class F (155 °C).**

More detailed technical information and the data sheets are available at www.vacuumschmelze.com.

Please scan the QR-code belonging to this chapter which will lead you automatically to the respective site.

Part number T60006-	Nominal core dimensions $d_o \times d_i \times h$ mm x mm x mm	Limiting dimensions (incl. case)			Iron cross section A_{Fe} cm ²	Mean path length l_{Fe} cm	Weight m g	A_L^*		Saturation current I_{cm}^{**} , typical	
		OD mm	ID mm	H mm				10 kHz nominal µH	100 kHz	10 kHz A	100 kHz A
L2009-W914	9.8 x 6.5 x 4.5	11.2	5.1	5.8	0.06	2.6	1.1	25.5	6.4	0.14	0.3
L2012-W902	12 x 8 x 4.5	14.1	6.6	6.3	0.07	3.1	1.7	28.0	6.8	0.15	0.31
L2012-W498	12.5 x 10 x 5	14.3	8.5	7.0	0.05	3.5	1.3	10.0	3.6	0.3	0.56
L2014-V098	14.4 x 11.4 x 3.2	16.5	9.6	5.0	0.04	4.1	1.1	10.5	2.6	0.21	0.44
L2015-W865	15 x 10 x 4.5	17.1	7.9	6.5	0.09	3.9	2.6	27.0	6.7	0.2	0.41
L2016-W403	16 x 10 x 6	17.9	8.1	8.1	0.14	4.1	4.0	43.0	9.8	0.2	0.41
L2016-W308								10.5	6.5	1.2	1.7
L2016-V165								2.1	2.0	5.4	5.7
L2017-W515	17.5 x 12.6 x 6	19.0	11.0	8.0	0.12	4.7	4.1	30.0	6.9	0.23	0.48
L2019-V184	19 x 15 x 5	21.2	13.0	7.3	0.08	5.3	3.1	18.0	4.1	0.26	0.54
L2019-W838	19 x 15 x 10	21.2	13.0	12.3	0.16	5.3	6.3	36.1	8.3	0.26	0.54
L2020-W409	20 x 12.5 x 8	22.6	10.3	10.2	0.24	5.1	9.0	57.0	13.0	0.25	0.51
L2020-W450								14.0	9.1	1.5	2.2
L2025-W523	25 x 20 x 10	27.6	17.4	12.8	0.20	7.1	10.0	28.4	6.5	0.41	0.84
L2025-W380	25 x 16 x 10	27.9	13.6	12.5	0.36	6.4	17.0	67.0	15.5	0.32	0.65
L2025-W451								17.1	11.5	1.8	2.7
L2025-W980								3.2	3.1	9.3	9.6
L2030-W423	30 x 20 x 10	32.8	17.6	12.5	0.40	7.9	23.0	66.0	15.8	0.36	0.73
L2030-W358								15.5	10.5	2.1	3.2
L2030-W981								2.9	2.8	12.0	12.0
L2030-W514	30 x 20 x 15	32.8	17.5	17.8	0.57	7.9	33.0	88.0	20.4	0.38	0.79
L2030-V188								26.9	16.2	1.8	2.8
L2030-V129								15.7	14.1	3.1	3.9
L2040-W422	40 x 32 x 15	43.1	28.7	18.5	0.46	11.3	38.0	48.0	11.2	0.55	1.1
L2040-V113								13.0	8.4	3.0	4.6
L2040-W452								10.2	7.9	3.8	5.2
L2040-W964								2.3	2.2	17.0	17.0
L2040-W424	40 x 25 x 15	43.1	22.5	18.5	0.86	10.2	64.0	99.0	23.1	0.5	1.0
L2040-W453								25.0	17.2	2.9	4.4



Table below



Part number T60006-	Nominal core dimensions $d_o \times d_i \times h$ mm x mm x mm	Limiting dimensions (incl. case)			Iron cross section A_{Fe} cm ²	Mean path length l_{Fe} cm	Weight m g	A_L^*		Saturation current I_{cm}^{**} , typical	
		OD mm	ID mm	H mm				10 kHz nominal μH	100 kHz	10 kHz A	100 kHz A
L2045-V102	45 x 30 x 15	48.3	26.4	18.2	0.86	11.8	74.0	87.6	20.0	0.59	1.2
L2045-V118								24.3	15.8	3.0	4.6
L2045-V101								15.7	14.1	4.6	5.9
L2050-W516	50 x 40 x 20	53.5	36.3	23.4	0.76	14.1	79.0	45.0	13.5	1.0	2.0
L2050-W565			36.3					18.0	10.0	3.6	5.5
L2050-V146			36.6					11.7	10.0	5.5	7.1
L2050-V166			36.6					3.1	3.0	20.0	21.0
L2054-V172	54 x 40 x 20	57.5	37.7	24.1	1.06	14.8	115.0	87.0	19.9	0.72	1.5
L2054-V178								24.0	15.7	3.7	5.8
L2063-W517	63 x 50 x 25	67.3	46.5	28.6	1.24	17.8	161.0	59.0	17.5	1.2	2.5
L2063-V110							161.0	23.3	13.8	4.5	6.9
L2063-V144							161.0	15.1	13.5	6.9	8.9
L2063-W985							163.0	3.3	3.3	30.0	31.0
L2080-V140	80 x 50 x 20	85.8	44.6	25.5	2.28	20.4	342.0	94.0	28.0	1.4	2.8
L2080-W531		86.0	44.7	25.7			342.0	35.0	24.0	5.5	8.4
L2080-V091		86.0	44.7	25.7			347.0	9.6	6.9	26.0	28.0
L2090-W518	90 x 60 x 20	95.4	54.7	24.7	2.28	23.6	395.0	81.0	25.1	1.7	3.3
L2090-V173							400.0	32.5	21.1	5.9	9.1
L2090-W984							400.0	4.6	4.5	41.0	42.0
L2100-V082	100 x 80 x 25	105.5	75.0	29.6	1.90	28.3	379.0	56.3	16.9	2.0	3.9
L2100-V081							379.0	14.6	13.1	11.0	14.0
L2102-W468	102 x 76 x 25	108.1	70.0	30.3	2.47	28.0	508.0	55.0	21.6	2.7	4.9
L2102-V080							508.0	19.1	17.2	11.0	14.0
L2102-W947							515.0	4.3	4.2	48.0	49.0
L2160-V074	160 x 130 x 25	166.9	123.9	30.5	2.74	45.6	917	28.0	14.0	8.5	14.0
L2160-V088					2.74		917	20.0	13.1	11.0	18.0
L2160-V066					2.74		917	13.0	11.7	18.0	23.0
L2160-W982					2.85		967	3.0	2.9	80.0	82.0

* A_L = inductance for N = 1 (tolerance +45% / -25%)

** I_{cm} : the listed saturation currents are guidelines only. They are calculated for nominal core dimensions at room temperature and for approx. 70% saturation flux density. The frequency-dependent saturation behaviour is demonstrated in fig. 12.

CORE STACK ASSEMBLIES WITH NANOCRYSTALLINE CORES

Single-turn chokes employing a number of nanocrystalline cores assembled in a stack are an effective solution for bearing current problems or extremely high common mode noise from other causes in large-scale variable speed drives, wind generators and other applications.

In these applications resonance phenomena cause high-amplitude interference currents with peak values ranging from several 10 A to over 100 A. These generally take the form of short and thus high-frequency current peaks. For these applications, VAC offers assembled core stacks which can be easily and securely integrated into existing applications with the minimum of effort.

The core stacks are available in two sizes with two different through-hole diameters. They are custom-designed, allowing an individual selection of core type and the number of stacked cores (up to 7 pieces) depending on the required saturation level and the required inductance.

More detailed technical information and the data sheets are available at www.vacuumschmelze.com. Please scan the QR-code belonging to this chapter which will lead you automatically to the respective site.

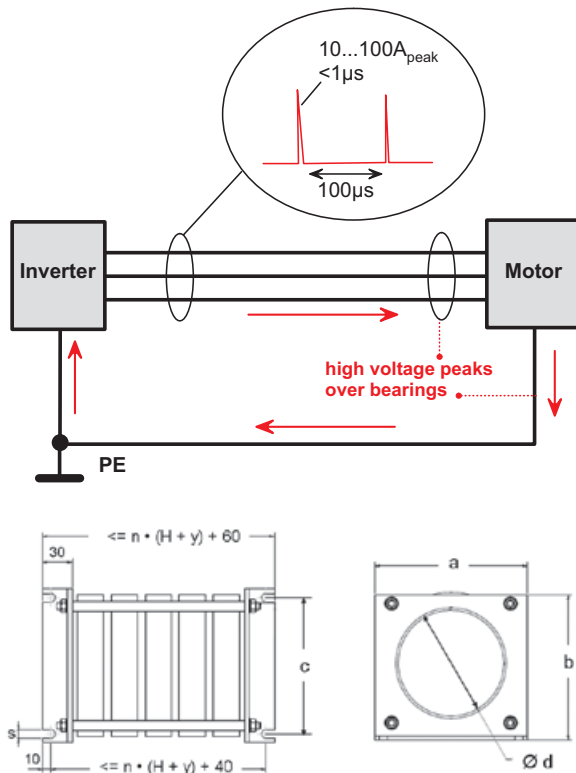

Dimensions of the core stack assemblies

	a	b	c	d	s
	(mm)	(mm)	(mm)	(mm)	(mm)
Size 1	120	130	70	~ 70	7
Size 2	180	190	130	>118	10

n = number of stacked cores

H = maximum core height

y = 9.5 for epoxy coated cores, T60004...

y = 10.2 for cased cores, T60006...

$L = n \cdot (H + y) + 60$

The inductance L of a core stack can be calculated by multiplying the number of stacked cores with the A_L -value of the single core.

A_L : inductance of single core

I_{cm} : maximum permissible leakage or common mode current

Calculated guideline for nominal core dimensions at room temperature and for approximately 70% saturation flux density.

Table below

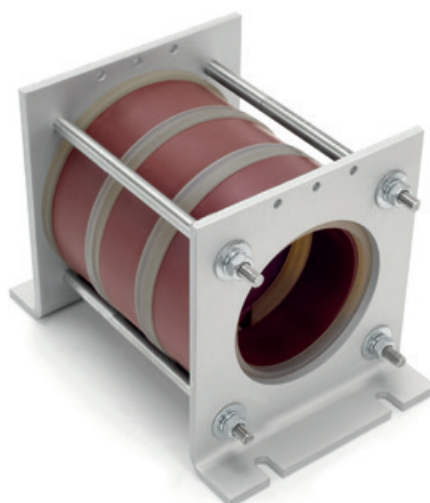

CORE DATA						DATA OF CORE STACK EXAMPLE FOR 5 STACKED CORES					
Core part number	Nominal core dimensions $d_o \times d_i \times h$ mm x mm x mm	Limit core dimensions (incl. case/coating)			A_L		Size	I_{cm}		L	
		OD mm	ID mm	H mm	10 kHz nominal μH	100 kHz nominal μH		10 kHz typical A	100 kHz typical A	10 kHz nominal μH	100 kHz nominal μH
T60004-L2100-W629	100 x 80 x 20	104.0	75.0	23.0	17.3	11.2	1	7.1	11.0	86.5	56.0
T60004-L2100-W723	100 x 80 x 20	104.0	75.0	23.0	11.2	10.0	1	11.0	14.0	56.0	50.0
T60006-L2100-V082	100 x 80 x 25	105.5	75.0	29.6	56.3	16.9	1	2.0	3.9	281.5	84.5
T60006-L2100-V081	100 x 80 x 25	105.5	75.0	29.6	14.6	13.1	1	11.0	14.0	73.0	65.5
T60006-L2102-W468	102 x 76 x 25	108.1	70.0	30.3	69.4	21.5	1	2.1	4.1	347.0	108.0
T60006-L2102-V080	102 x 76 x 25	108.1	70.0	30.3	19.1	17.2	1	11.0	14.0	95.5	86.0
T60006-L2102-W947	102 x 76 x 25	108.1	70.0	30.3	4.3	4.2	1	48.0	49.0	21.5	21.0
T60006-L2160-V074	160 x 130 x 25	166.9	123.9	30.5	28.0	14.0	2	8.5	14.0	140.0	70.0
T60006-L2160-V088	160 x 130 x 25	166.9	123.9	30.5	20.0	13.1	2	11.0	18.0	100.0	65.5
T60006-L2160-V066	160 x 130 x 25	166.9	123.9	30.5	13.0	11.7	2	18.0	23.0	65.0	58.5
T60006-L2160-W982	160 x 130 x 25	166.9	123.9	30.5	3.0	2.9	2	80.0	82.0	15.0	14.5

In case of interest for a specific core stack with 2-7 cores chosen from above list please contact VAC.

Existing Core Stacks

Core stack part number	Nominal core dimensions (part number) x number of cores $d_o \times d_i \times h$ mm x mm x mm	Nominal core stack dimensions		A_L		Size	I_{cm}	
		base dimension (L x a) mm	height (b) mm	10 kHz nominal μH	100 kHz nominal μH		10 kHz typical A	100 kHz typical A
T60016-L2102-W075	102x76x25 (W947) x2	140x120	130	9.1	8.4	1	48	49
T60016-L2102-W078	102x76x25 (W468) x6	300x120	130	416	130	1	2.1	4.1
T60016-L2160-W076	160x130x25 (W982) x5	261x180	190	16	14.5	2	80	82
T60016-L2160-W079	160x130x25 (V066) x4	210x180	190	52	46.8	2	18	23
T60016-L2160-W080	160x130x25 (V066) x7	310x180	190	91	81.9	2	18	23
T60016-L2160-W081	160x130x25 (V066) x5	240x180	190	65	58.5	2	18	23

COMMON MODE CHOKES UL1446 STANDARD SERIES

Common Mode Chokes using VITROPERM cores offer universal solutions for various EMI problems due to highest inductance at a low number of turns in compact designs, excellent high frequency properties and stable performance over a wide temperature range.

All standard types in low profile or upright constructions are designed for operation in grid connected RFI filters or for applications with higher operating voltages. Construction, production and testing of the chokes are in accordance with **EN50178, resp. IEC 62109**. The plastic materials comply with the following UL standards **UL94-V0/HB for small chokes (file number E41871) and UL1446 (file number OBJ2.E329745) for temperature class B (130 °C)**.

Example: low profile

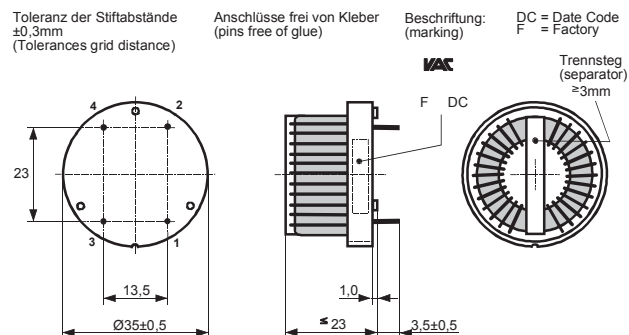

upright profile

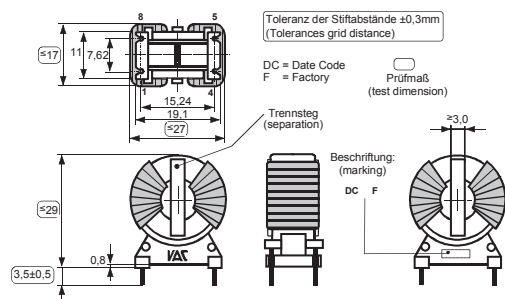

GENERAL INFORMATION

- I_N = nominal current in each winding
- $U_{N\text{ OVCat III/II}}$ = operating voltage for overvoltage category III/II
- L_N = nominal inductance, tolerance +50% / -30%
- Ambient temperature $T_a = -40\text{ °C} \dots +70\text{ °C}$ (short-term +90 °C)
- Operating temperature $T_{op} = -40\text{ °C} \dots +130\text{ °C}$ (short-term +150 °C)
- R_{Cu} : winding resistance per winding
- $|Z|$: choke impedance
- f_R : choke resonance frequency

The standard chokes are designed for a temperature rise of $\Delta T = 45 \dots 60\text{ K}$ at $T_a = 70\text{ °C}$ and $I = I_N$ in each winding. Data derating is necessary for deviating ambient temperature or deviating nominal current. Please contact VAC for further detailed information.

More detailed technical information and the data sheets are available at www.vacuumschmelze.com.

Please scan the QR-code belonging to this chapter which will lead you automatically to the respective site.

1-PHASE CMCs

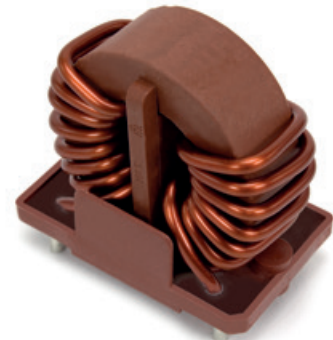

For comfortable CMC selections please download our software tool (requires Microsoft EXCEL): **VAC CMC Quick-Selector**. If suitable standard CMCs are not available in the table below, please contact us using our **design check list (printed on page 26/27, QR-Code: page 24)**. For testing purposes, VAC offers special sample kits consisting of standard CMCs **CMC Sample Kit (QR-Code page 24)**.

Further types

Table below



STANDARD SERIES CMCs FOR 1-PHASE APPLICATIONS

Part number T60405-	I _N A	Design	U _N OVCat III/II V	L _N		R _{cu} mΩ	Z 100 kHz Ω	f _R MHz	I _{cm} 10 kHz mA	Dimensions		
				10 kHz mH	100 kHz mH					l mm	w mm	h mm
R6131-X402	2	upright	300/600	2 x 12.1	2 x 2.8	101.7	3000	3.6	12	22	12	25
R6131-X204	4.5	upright	300/600	2 x 10.8	2 x 2.5	27.5	2320	1	12	22	12	25
R6161-X504	5	upright	300/600	2 x 28.3	2 x 6.6	35.6	6500	0.4	10	27	17	29
R6166-X206	6	upright	300/600	2 x 29.1	2 x 6.7	37.6	8500	0.25	14	35	21	37
R6166-X208	8.5	upright	300/600	2 x 16.4	2 x 3.7	19.1	4200	0.5	17	35	21	36.5
R6123-X210	10	low profile	300/600	2 x 11.4	2 x 2.6	12	3200	0.7	16	35	35	23
R6166-X210	10	upright	300/600	2 x 11.4	2 x 2.6	12.7	3150	0.7	16	35	21	37
R6126-X212	12	upright	300/600	2 x 11.4	2 x 2.6	9	2950	0.7	22	38	22	35
R6123-X213	12.4	low profile	300/600	2 x 11.4	2 x 2.6	8.8	2950	0.7	22	35	35	25
R6122-X095	13.5	upright	600/1000	2 x 16.9	2 x 3.6	7.6	4000	0.7	22	41	21	37
R6102-X016	13	low profile	300/600	2 x 8.6	2 x 2.2	6.3	2250	1.1	28	35	35	22.5
R6123-X616	16	low profile	300/600	2 x 12.9	2 x 3.1	5.7	3000	3	26	40	40	24
R6126-X216	16	upright	600/1000	2 x 5.3	2 x 1.3	2.8	1300	3.5	40	41.5	23.5	40
R6166-X033	18	upright	300/600	2 x 6	2 x 1.5	4.6	1600	1	35	38	21	38
R6166-X039	18	upright	300/600	2 x 2.9	2 x 0.7	3.9	830	3.3	50	36	21	38
R6123-X220	20.5	low profile	300/600	2 x 1.8	2 x 0.4	3.2	500	11.5	40	35	35	23.5
R6123-X221	20	low profile	300/600	2 x 6.6	2 x 1.6	2.9	1470	4.5	35	43	43	24
R6128-X220	20	upright	600/1000	2 x 5.6	2 x 1.3	2.8	1300	3.6	40	42	27	38
R6123-X226	25	low profile	300/600	2 x 4.2	2 x 1	1.9	970	7.1	45	43	39.5	25
R6123-X227	25	low profile	600 / 1000	2 x 12	2 x 2.8	3.5	2900	2.2	45	52	52	32
R6128-X225	25	upright	300/600	2 x 4.2	2 x 1	1.9	970	4.9	45	42	27	40
R6128-X226	25	upright	600/1000	2 x 12	2 x 2.8	3.3	3000	1.5	40	52	28.5	48.5
R6123-X232	30	low profile	600 / 1000	2 x 3.9	2 x 0.9	2.4	920	7	50	52	52	29
R6128-X031	30	upright	600 / 1000	2 x 3.9	2 x 0.9	2.3	900	4	65	51	27	50
R6128-X230	30	upright	600 / 1000	2 x 6.3	2 x 1.5	2.3	1620	2.7	55	52	27	47
R6123-X241	40	low profile	600 / 1000	2 x 3.6	2 x 0.8	1.4	870	6	90	52	52	32
R6123-X248	46	low profile	600 / 1000	2 x 2.5	2 x 0.6	1	660	5.7	100	57	51	33
R6123-X263	63	low profile	600 / 1000	2 x 1.6	2 x 0.4	0.5	390	9.3	120	56	56	32
R6123-X285	85	low profile	600 / 1000	2 x 1.6	2 x 0.5	0.6	510	1.6	200	73	73	40

3-PHASE CMCs

Tolerances grid distance
±0.3 mm

DC = Date Code
F = Factory

Marking
VAC

Separation
≥5.5 mm

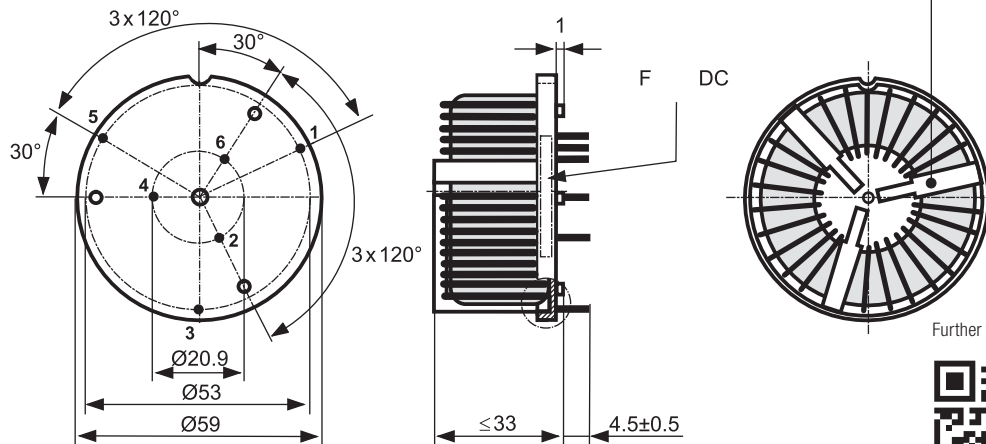

Further types

Table below

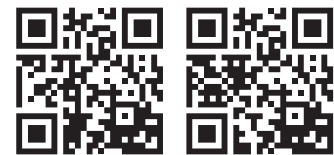

Example outline of the 3-phase CMC T60405-S6123-X332.

STANDARD SERIES 3-PHASE CHOKES FOR 3-PHASE APPLICATIONS

Part number T60405-	I _N A	Design	U _N OV Cat III/II V	L _N		R _{Cu} typ. mΩ	Z 100 kHz Ω	f _R typ. MHz	I _{cm} 10 kHz mA	Dimensions		
				10 kHz mH	100 kHz mH					l mm	w mm	h mm
S6123-X306	7	low profile	600/1000	3 x 31.8	3 x 7.4	24.6	8650	0.23	22	40.5	40.5	32.5
S6123-X310	10	low profile	600/1000	3 x 13.9	3 x 3.2	14	3500	1.6	30	51	51	32
S6123-X308	11	low profile	600/1000	3 x 10.6	3 x 2.5	8.5	2600	0.8	35	42	42	32
S6123-X312	12	low profile	600/1000	3 x 5.7	3 x 3.7	11.8	2650	0.48	150	51	51	32
S6123-X315	16	low profile	600/1000	3 x 4.3	3 x 1	2.9	1050	2.5	50	42	42	32
S6123-X316	16	low profile	600/1000	3 x 4.8	3 x 3.1	6.5	2500	0.65	200	59	59	32
S6123-X317	16	low profile	600/1000	3 x 9.4	3 x 2.2	5.9	2400	1.5	35	51.5	51.5	34
S6123-X320	20	low profile	600/1000	3 x 10.6	3 x 2.4	4.1	2650	0.9	60	59	59	33
S6123-X321	20	low profile	600/1000	3 x 4.8	3 x 1.1	2.8	1200	2.4	55	52	52	34
S6123-X325	25	low profile	600/1000	3 x 2	3 x 1.3	2.27	1000	2.8	380	60	60	33
S6123-X326	25	low profile	600/1000	3 x 4.9	3 x 1.1	2.1	1150	2	60	51.5	51.5	32
S6122-X326	26	upright	600/1000	3 x 10.6	3 x 2.4	3.5	2500	0.9	55	64	35	65
S6122-X329	29	upright	300/600	3 x 3.6	3 x 0.8	1.7	850	3.3	80	64	32	58
S6123-X332	32	low profile	600/1000	3 x 1.2	3 x 0.8	1.4	600	4.9	480	59	59	33
S6122-X333	32	upright	600/1000	3 x 1.2	3 x 0.8	1.6	660	3.5	420	64	32	60
S6123-X140	40*	low profile	600/1000	3 x 2.5	3 x 0.6	1.2	600	4.7	100	52	52	33
S6123-X240	40*	low profile	600/1000	3 x 1.5	3 x 0.8	1.72	680	4	380	70	70	37
S6123-X363	63	low profile	600/1000	3 x 1.6	3 x 0.5	0.72	500	1	170	70	70	42
S6123-X370	70	low profile	600/1000	3 x 0.8	3 x 0.5	0.86	415	1.7	900	82	82	50
S6123-X311	110	low profile	600/1000	3 x 0.7	3 x 0.6	0.63	430	1.3	1750	135	135	57

4-FOLD CMCs



Table below



More detailed technical information and the data sheets are available at www.vacuumschmelze.com.
Please scan the QR-code belonging to this chapter which will lead you automatically to the respective site.

STANDARD SERIES 4-FOLD CHOKES

Part number	I_N A	Design	U_N OVCat III/II V	L_N		R_{Cu} typ. mΩ	Z 100 kHz Ω	f_r typ. MHz	I_{cm} 10 kHz mA	Dimensions		
				10 kHz mH	100 kHz mH					l mm	w mm	h mm
S6123-X400	10** 12*	low profile	600/1000	4x6.9	4x1.6	7.66	1500	1.4	40	51	51	33
S6123-X401	16** 20*	low profile	600/1000	4x3.6	4x0.8	2.75	860	3.4	90	51.5	51.5	33
S6123-X402	24** 30*	low profile	600/1000	4x3.2	4x0.7	1.5	750	3.5	100	60	60	33.5
S6123-X403	32** 40*	low profile	600/1000	4x1.4	4x0.3	0.82	360	7	160	60	60	33

* for $T_a \leq 60^\circ\text{C}$

** for $T_a \leq 85^\circ\text{C}$

CMCs FOR HIGH POWER CENTRAL AND UTILITY GRADE PHOTOVOLTAIC-INVERTERS UP TO THE MW-RANGE



¹ Design example: $I_{rms} = 2 \times 400 \text{ A}$, $L = 2 \times 1.5 \text{ mH}$, $U_{is} = 1000 \text{ V}_{rms}$,
mechanical dimension 276 mm x 287 mm
(without cable and cable lugs)



FURTHER DESIGN SUPPORT



For CMC selections (even at deviating operational data) please download our software tool (requires Microsoft EXCEL) VAC CMC Quick Selector which can be accessed using the QR-codes in this brochure that link to the product pages.

If you cannot find a suitable CMC from the listed standard range, please contact us using our design checklist.



VAC Design Checklist



For testing purposes, VAC offers special sample kits consisting of tape-wound cores Core Sample Kit VITROPERM and Common Mode Chokes CMC Sample Kit.



Core Sample Kit (Content)



CMC Sample Kit (Content)

CMC DESIGN CHECKLIST (EN50178) – 1/2

For IEC 62109/IEC61800 please use the separate checklist from our website.

Company name:		Contact person:	
Address:		Tel.:	
<input type="checkbox"/> New project <input type="checkbox"/> Replacement for:		E-Mail:	
Application (please specify in more detail):	<input type="checkbox"/> SMPS/UPS: <input type="checkbox"/> Drives/Inverter: <input type="checkbox"/> Solar/Photovoltaic: <input type="checkbox"/> Welding: <input type="checkbox"/> Other:	Power:	Date:
		kW	Project name(s), description:
Expected annual usage [pcs.]:	Year 1	Year 2	Year 3
	Year 4	Target price [€]:	
Sample quantity:	pcs.	Sample date:	SOP:
		Product life cycle [years]:	

Operational Characteristics

Number of windings:		Rated voltage ¹⁾ :	
Nominal load current:	A (RMS or DC)	OVCat 3:	V <input type="checkbox"/> RMS <input type="checkbox"/> DC
Overload current:	A for s	OVCat 2:	V <input type="checkbox"/> RMS <input type="checkbox"/> DC
Nominal impedance:	Ω @ kHz	Pollution degree (typ. 2):	
Nominal inductance:	mH @ 10 kHz mH @ 100 kHz	Max. ambient temperat.:	°C
Switching frequency:	kHz	Max. operational temp.:	°C
Max. Common Mode Current: (leak. curr. / unbalanced current / noise)	mA @ LF (<20kHz) mA @ kHz	Cooling mechanism:	<input type="checkbox"/> Convection
Leakage inductance:	μ H	Forced cooling Fan:	<input type="checkbox"/> m/s
Results from own tests: Core:		Heat sink:	<input type="checkbox"/> K/W
No of turns:		Copper resistance R_{Cu} :	Ω
(Number of strands) $\times \varnothing_{Cu}$:	\times mm	Casing construction:	
Max. dimensions: W \times D \times H:	$\times \times$ mm	Design:	upright <input type="checkbox"/> low profile <input type="checkbox"/>
		PTH <input type="checkbox"/> SMD <input type="checkbox"/>	Cable Lugs <input type="checkbox"/>
		Pinning already fixed:	<input type="checkbox"/> yes <input type="checkbox"/> no

¹⁾ typically: Overvoltage Category 3 = connected to mains, Overvoltage Category 2 = not connected to mains

Additional Specifications

Electrical standards:	<input type="checkbox"/> EN50178	<input type="checkbox"/> UL	<input type="checkbox"/> other:	<input type="checkbox"/> none	For IEC62109 and IEC61800 please use separate checklist
Environmental demands:	Vibration:	Humidity:	Dust:		
QM-Requirement:	<input type="checkbox"/> ISO 9001	<input type="checkbox"/> TS16949	<input type="checkbox"/> Others:		

Filter Design:

Filter:	1-stage <input type="checkbox"/>	2-stage <input type="checkbox"/>	multi-stage <input type="checkbox"/> (No. of stages:)
Schematic:	draft on page 2 <input type="checkbox"/>	separate attachment <input type="checkbox"/>	

CMC DESIGN CHECKLIST (EN50178) – 2/2

Further comments:

Draft of filter schematic:

VACUUMSCHMELZE CHINA MAGNETICS

Shanghai Sales Office
Room 06, 19F
Zhongrong Hengrui International Plaza
620 Zhangyang Road, Pudong District
Shanghai, PRC 200122
Phone +86 21 58 31 98 37
Fax +86 21 58 31 99 37
vac_china@vacuumschmelze.com

VACUUMSCHMELZE GMBH & CO. KG

Grüner Weg 37
D 63450 Hanau / Germany
Phone +49 6181 380
Fax +49 6181 382645
info@vacuumschmelze.com
www.vacuumschmelze.com

VAC MAGNETICS LLC

2935 Dolphin Drive
Suite 103
Elizabethtown, KY 42701
Phone +1 270 769 1333
Fax +1 270 769 3118
info-usa@vacmagnetics.com

Published by VACUUMSCHMELZE GmbH & Co. KG, Hanau
© VACUUMSCHMELZE GmbH & Co. KG 2021. All rights reserved.

® is a Registered Trademark of VACUUMSCHMELZE GmbH & Co. KG



ADVANCED MAGNETIC SOLUTIONS